



SONORASTONE WALL CAP

ARCHITECTURAL PRECAST CONCRETE PRODUCTS

Sonorastone® Peaked Wall Cap

...offers the ultimate in durable, aesthetic hardscape. The beautiful slate texture of Sonorastone® Wall Cap, by Stepstone, Inc. has the look and feel of natural stone. The Sonorastone® Wall Cap System combines sophisticated, elegant detailing with high strength, precast concrete.



Visit Our Website

www.stepstoneinc.com
• Classic Wall Cap • Pavers
• Pool Coping • Stair Treads



SONORASTONE WALL CAP
ARCHITECTURAL PRECAST CONCRETE PRODUCTS

*See actual color concrete samples before ordering.

Variegated Colors

Solid Colors

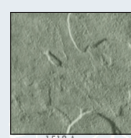
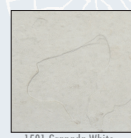
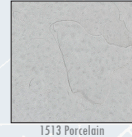
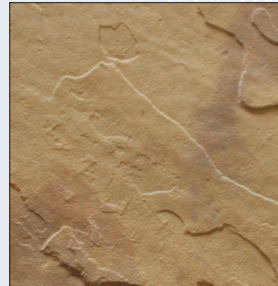
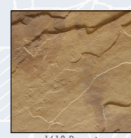
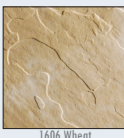
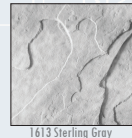
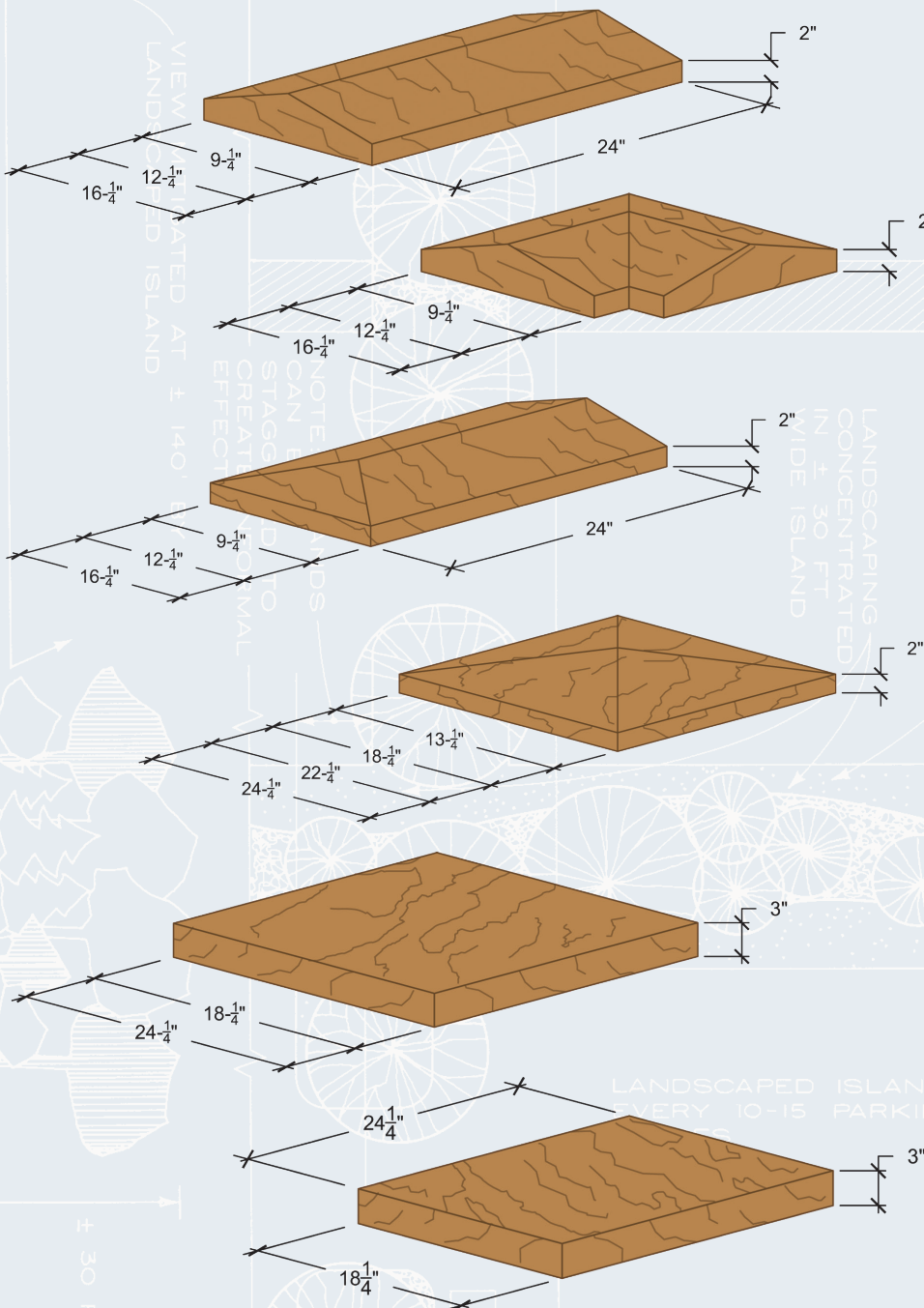

Material: 4,000 PSI Concrete

PLEASE NOTE: All of our products are made by hand from natural materials. Variations in color are to be expected. To confirm color, please refer to actual concrete samples before placing order. Some minor chipping may result from shipping, but is not detrimental to appearance or function. All sizes are nominal. See details for further information. Available in other standard colors.